



P.O. Box 68323, Bryanston 2021
200 Cussonia Park, 3 Ridge Road,
Laser Park, Honeydew, South Africa.
Tel: (011) 794-6311 • Fax: (011) 794-6233

INSTALLATION INSTRUCTIONS



INSTALLATION WARNING:

1. It is important that all K9 Racks and accessories are correctly attached (fastened) and secured to your vehicle.
2. Negligent installation of the K9 Rack and accessories could lead to an unfortunate vehicle accident. Furthermore injury and cause bodily harm or even lead to the demise of other folk.
3. Remember you are personally responsible in securing and checking the installation of your K9 Rack on your vehicle.
4. Once fitted the K9 Rack installation should be checked on a regular basis and if need be adjusted or secured.
5. Before you commence installation of your K9 Rack it is imperative that you read the instructions thoroughly to understand and be prepared for the assembly.
6. Should you not fully understand the assembly and installation instructions of the K9 Rack and you are apprehensive that you do not have the technical or mechanical know-how it would be in your interest to have the K9 Rack installed by a qualified professional at a garage or fitment centre.
7. Lastly it is extremely important that your equipment including the weight of the K9 Rack does not exceed your vehicles maximum roof load specifications.
8. In order to obtain your vehicle specifications one would need to contact your vehicle manufacturer or distributor or look in your service book provided with your vehicle.



**SECTION 1:
MOUNTING A K9 ROOF RACK ONTO A VEHICLE
WITH GUTTERS, RAIN CHANNEL**

GETTING STARTED:
10mm spanner, wrench
13mm spanner, wrench
4mm allen key
5mm allen key
6mm allen key
Measuring tape

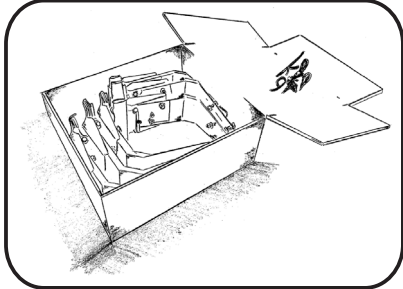

Once K9 leg box is opened, place in an accessible position.

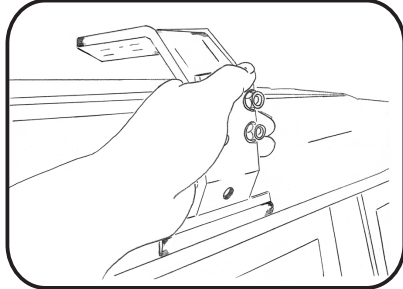

Remove leg from box, place in the gutter (rain channel) of the vehicle in order to obtain the correct height.

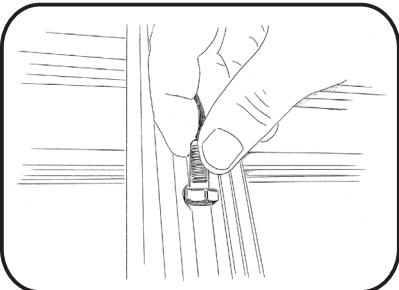

Remove rack from box, turn upside down and slot bolts into position onto slide rail.

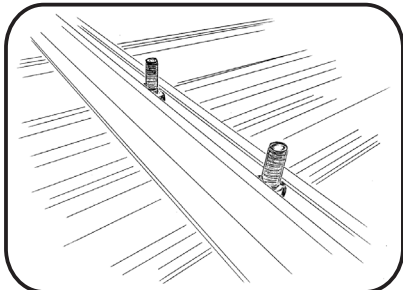

Two bolts per side on each slide rail that the legs are to be mounted to.

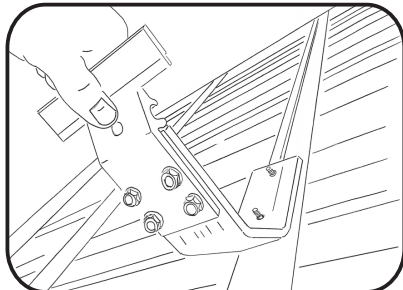

Place legs on slide rail into position.

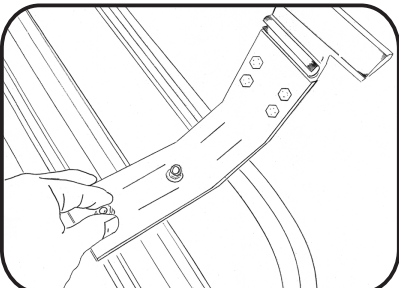

Thread nyloc nuts onto bolts.

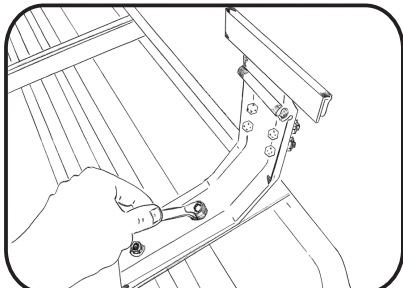

Secure with 13mm spanner/wrench but leave loose that they can still move.

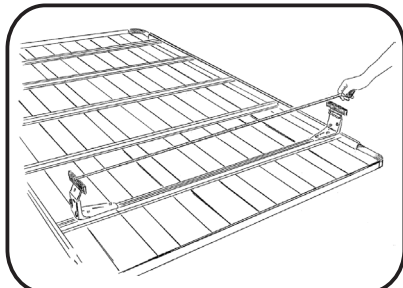

Use a measuring tape and adjust roof rack legs to the measurement required.

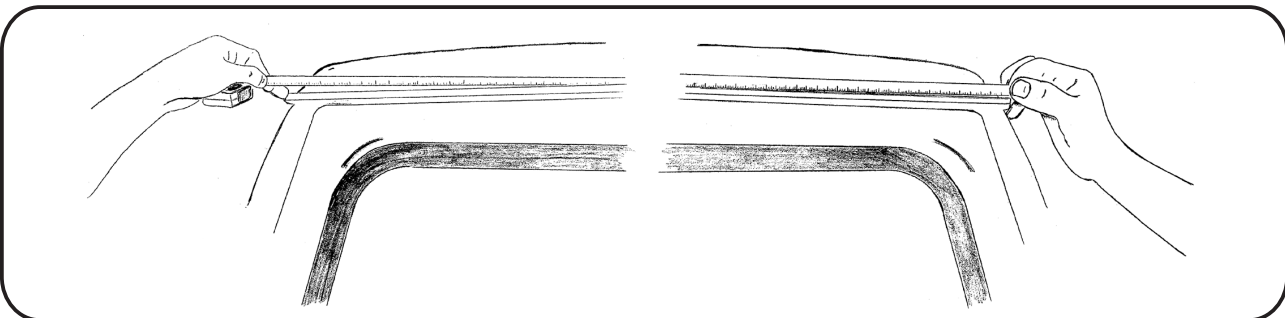

Ask someone to help measure the gutter (rain channel) width of the vehicle with a measuring tape.

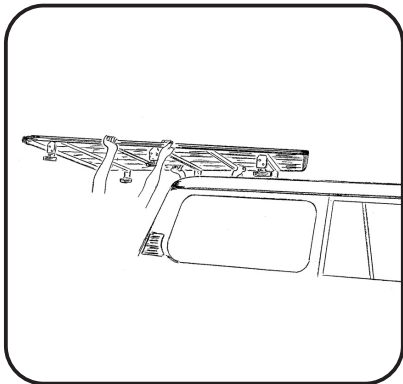

Turn K9 roof rack right side up and walk it over vehicle.

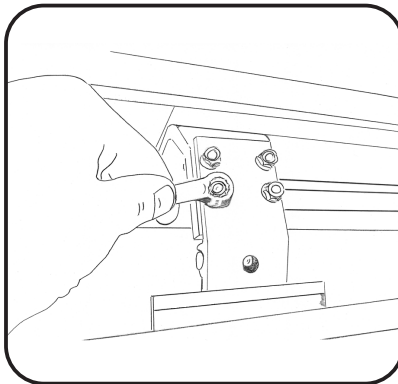

Adjust legs to desired angle and secure.

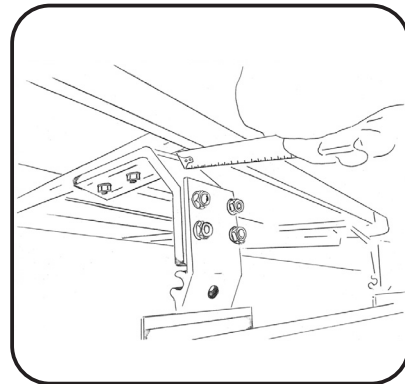

In order to centralize a K9 rack on vehicle use a measuring tape.

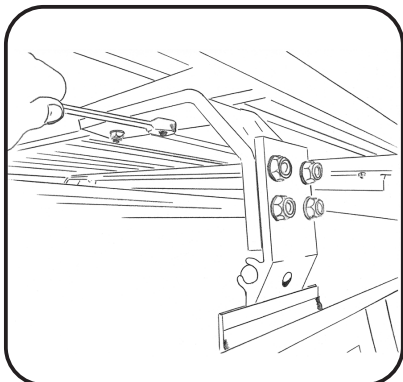

Fully tighten nyloc nuts with 13mm spanner/wrench on slide rail bolts.



Place K9 clamp in position and hand tighten. This should be done to all clamps provided.

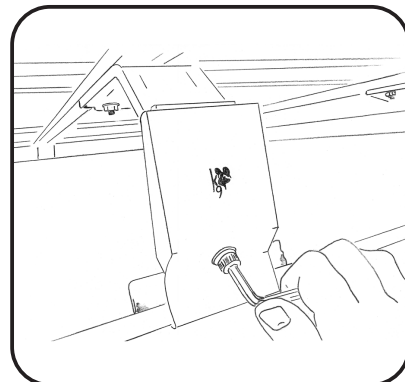

Systematically tighten K9 clamp with 6mm allen key. Do not over tighten.

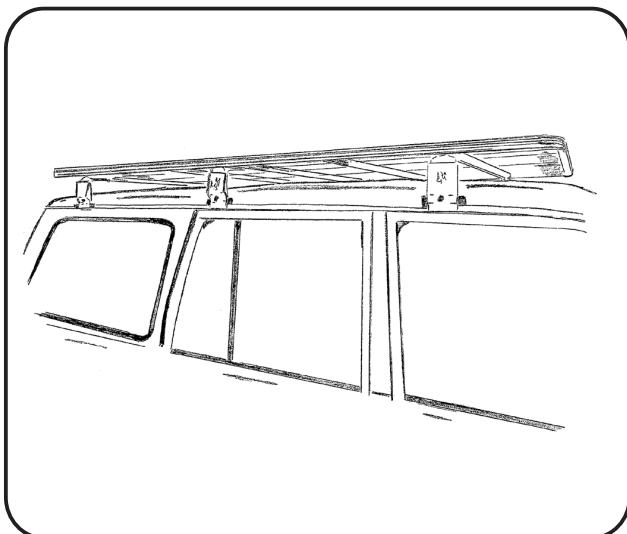

Make sure all bolts and nuts are secure before driving off.

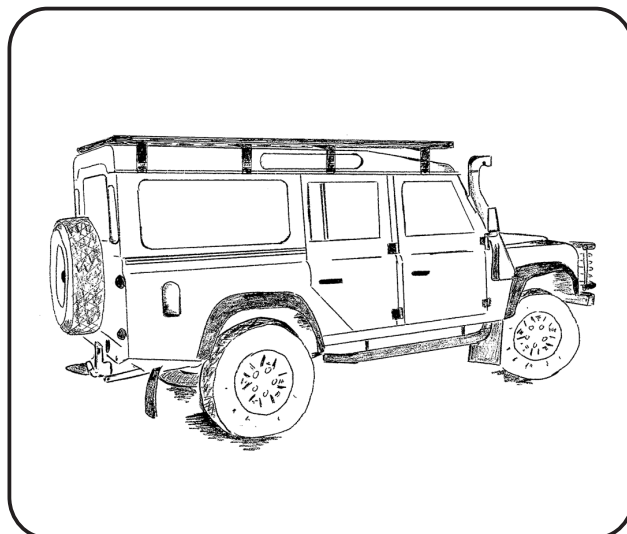

JOB WELL DONE!

SECTION 2: MOUNTING A K9 ROOF RACK ONTO A VEHICLE WITHOUT GUTTERS, RAIN CHANNELS OR WITH OME BARS:

GETTING STARTED:

10mm spanner, wrench
12mm spanner, wrench
13mm spanner, wrench
4mm allen key
5mm allen key
Measuring tape

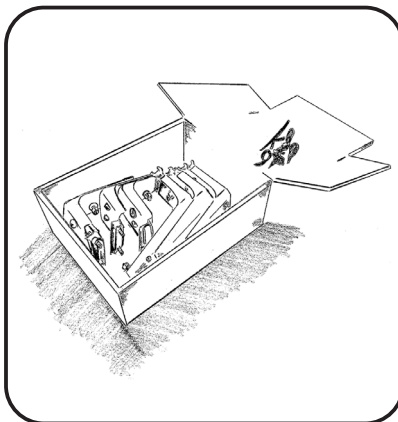

Once K9 leg box is opened, place in an accessible position.

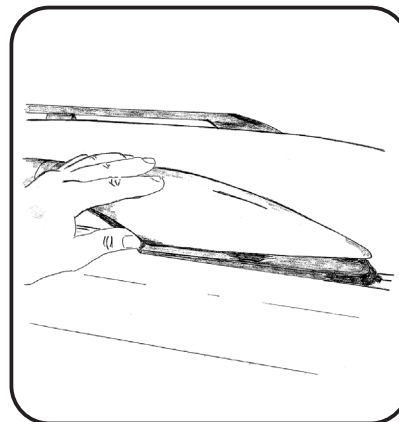

In order to remove plastic covers on OME factory bars to access mounting bolts push down and pry sides away to unclip.

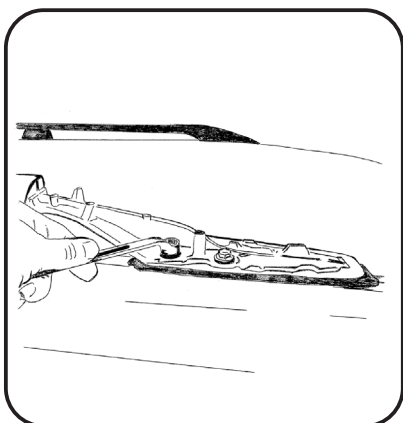

Remove bar with 12mm spanner/wrench.

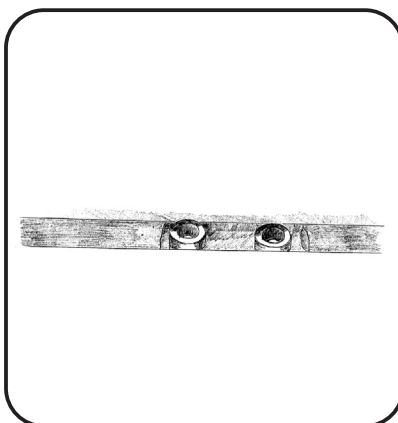

Place aluminium spacers provided into slots and align with holes.

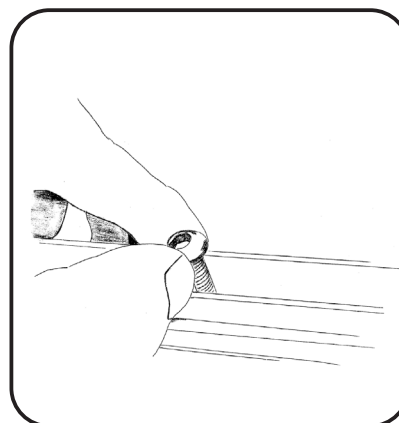

Place rail into correct position and thread in bolts.

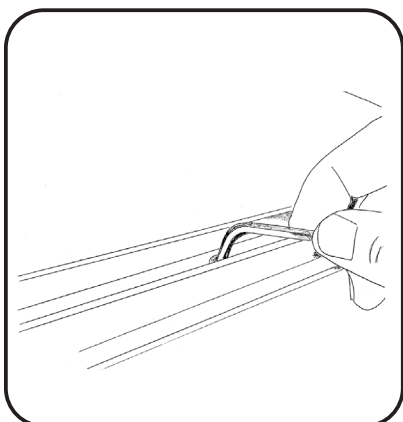

Tighten with 5mm allen key. Tighten each bolt systematically.

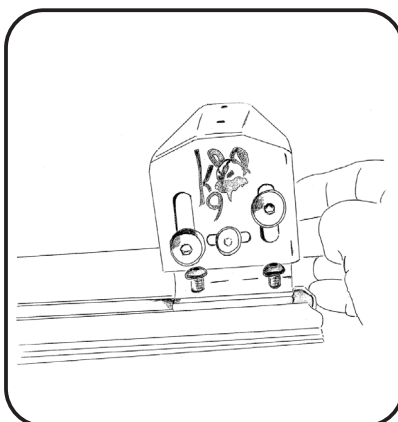

Slide K9 legs into rail.

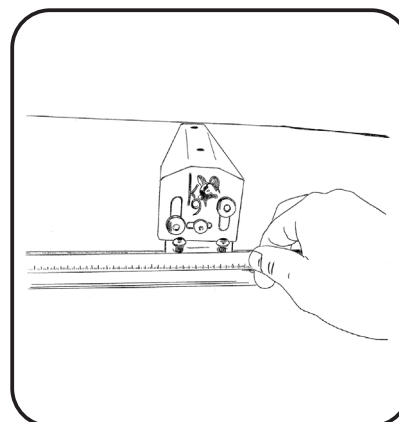

By using a tape measure adjust distance to slide rails on K9 rack.

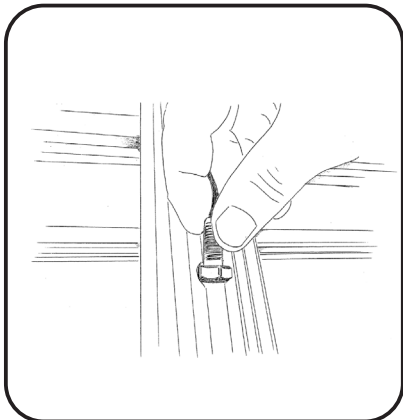

Remove rack from box, turn upside down, slot bolts into position onto slide rail.

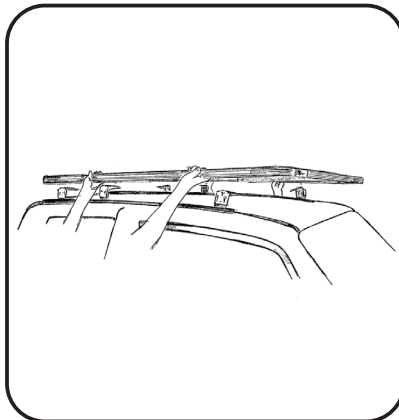

Turn K9 roof rack right side up and walk it over vehicle.

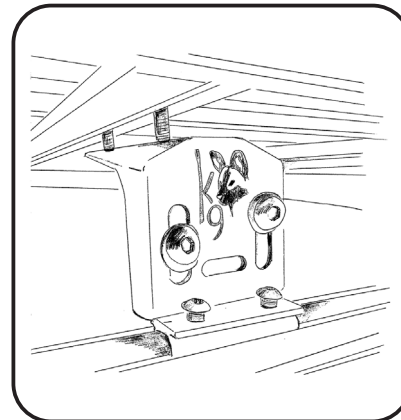

Align K9 legs with bolts on roof rack slide rails.

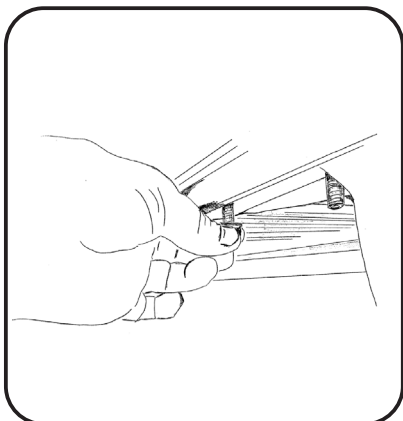

Thread nyloc nuts onto bolts.

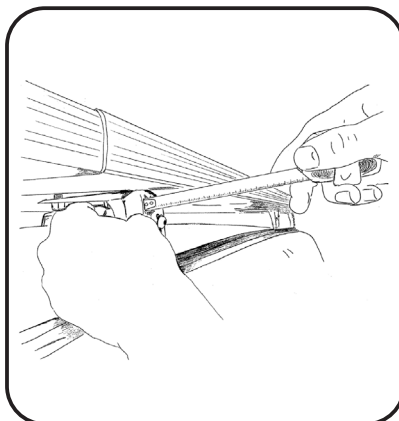

In order to centralize K9 rack on vehicle, use a measuring tape.

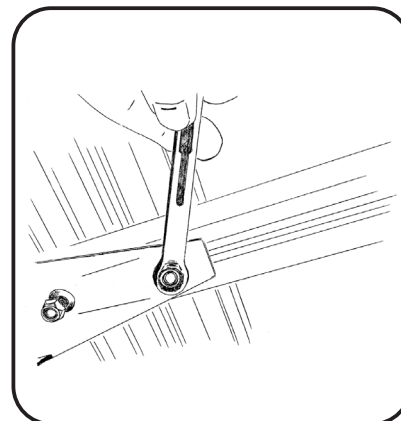

Fully tighten nyloc nuts with 13mm spanner/wrench on slide rails.

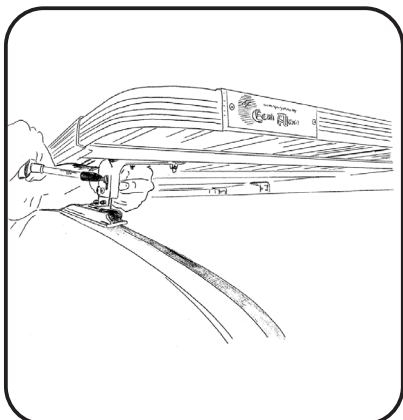

Adjust leg to height required and tighten.

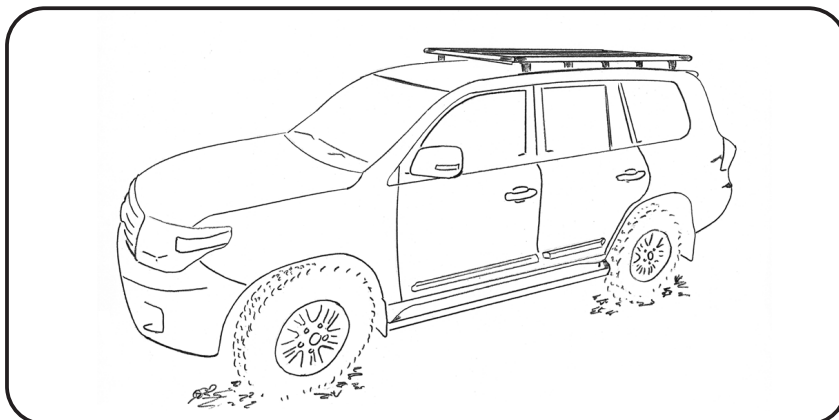

JOB WELL DONE!



MOUNTING RAILS ONTO A CANOPY OR JEEP JK 2015 MODEL. REFER TO SECTION 2 WITH REGARDS TO MOUNTING THE RACK:

GETTING STARTED:

- 10mm spanner
- 4mm allen key
- Blade or knife
- 6.5mm drill bit
- 12mm drill bit
- Drill
- Marking pen
- Tape measure

For ease of fitting - remove canopy from vehicle

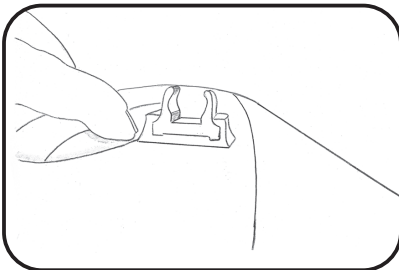

Place the rail roof up against inside of outer rib at the back of Jeep.

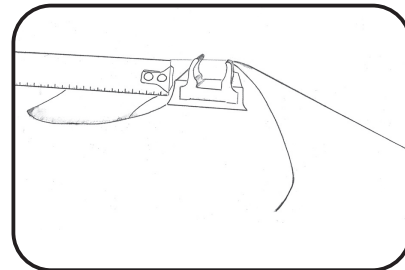

Measure with a tape 7mm from top of rib.

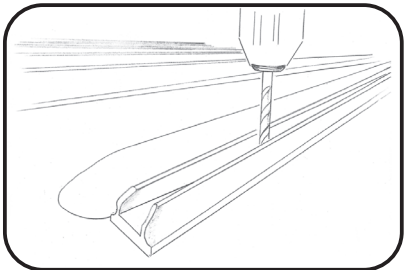

Drill small pilot hole first.

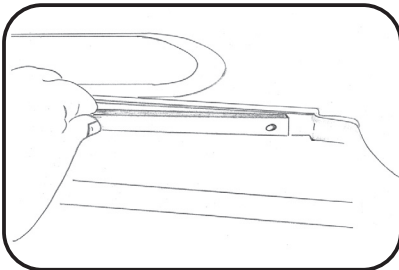

Check in the inside to make sure that holes are in the correct position in the inside the plates should fit onto the flat recess.

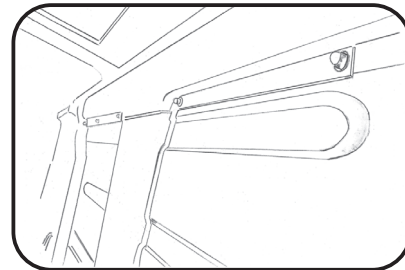

Finish drilling and secure plates and rails and place plastic caps on nuts.

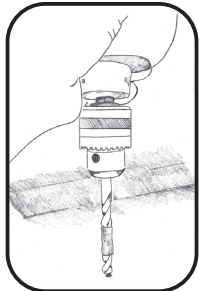
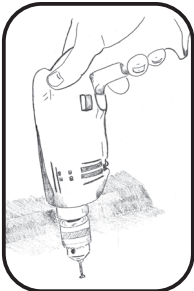

Using a small drill bit 5mm or smaller drill a pilot hole. Change drill bit to the finished hole required. Place tape around drill bit in order to stop the bit going too deep.

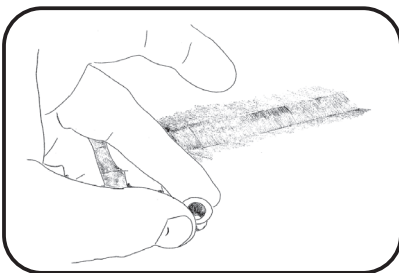

Rubber riv nuts should be used in the front.

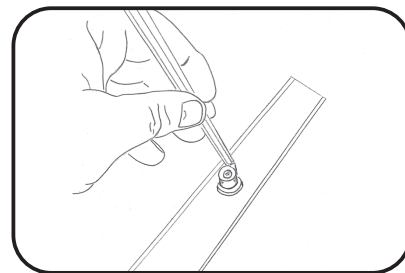

Before securing turn rail upside down, mark hole to be cut with a marking pen draw around rubber riv nut.

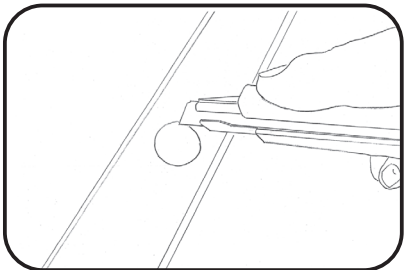

Cut hole out in rail rubber to accommodate rubber riv nut. Hole can be cut round or square.

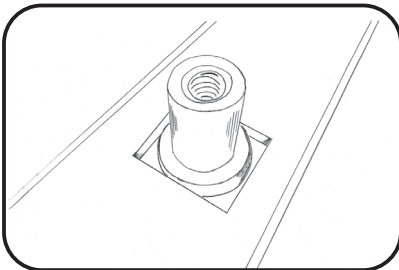

Make sure rubber riv nut fits in hole. Turn rail over and secure to roof.

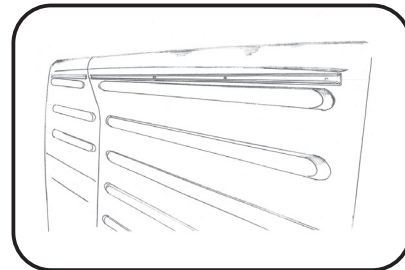

This allows rail to sit flush with roof. **JOB WELL DONE!**

(SHOULD YOU HAVE A OLDER MODEL JK PLEASE CONTACT YOUR NEAREST DISTRIBUTOR FOR INSTRUCTIONS)

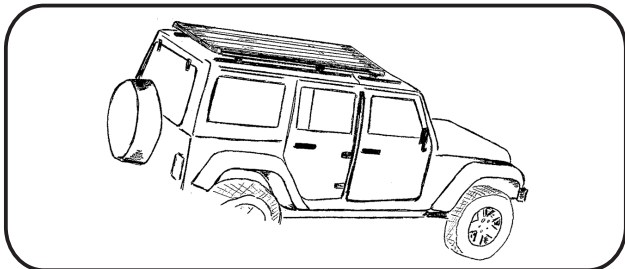

In order to mount rack refer to section 2.

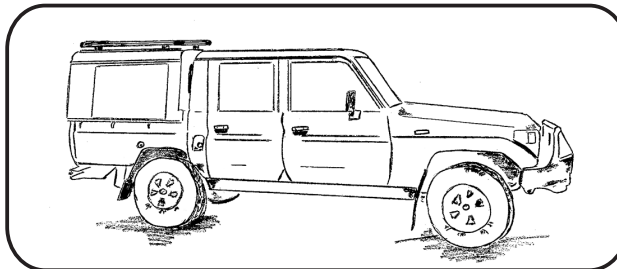

JOB WELL DONE!

SECTION 4: MOUNTING LEGS ONTO A DISCOVERY 3 OR 4 REFER TO SECTION 2 WITH REGARDS TO MOUNTING THE RACK:

GETTING STARTED:
13mm spanner/wrench
Tape measure
4mm allen key
5mm allen key

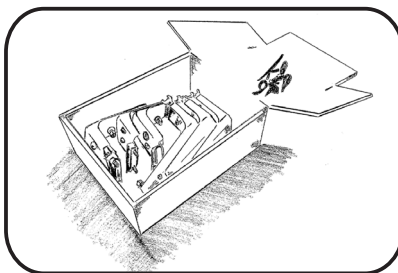

Once K9 leg box is opened, place in an accessible position.

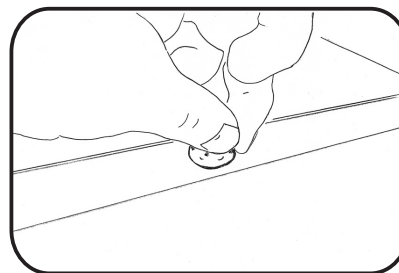

Remove plastic cap in rubber roof strip above front doors.

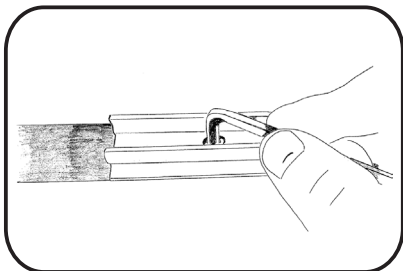

Secure rail with 4mm allen key down into position.

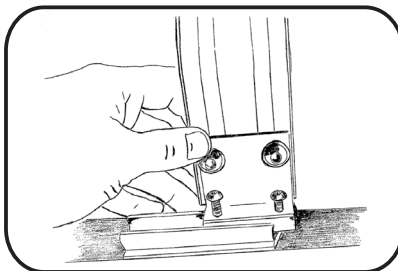

Slide front leg onto rail.

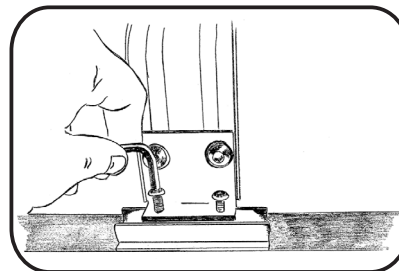

Adjust front leg so as it is level with vehicles roof and secure with 4mm allen key.

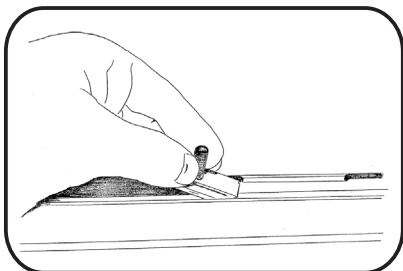

Insert 4 K9 roof rack slides into OME bars each side.

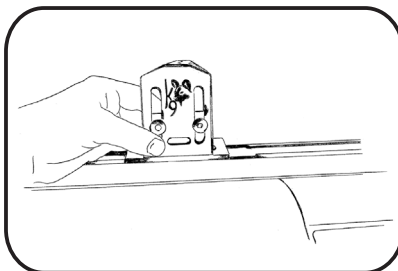

Attach K9 roof rack legs and secure with 13mm spanner/wrench but leave so that they can still move. In order to mount rack refer to section 2.

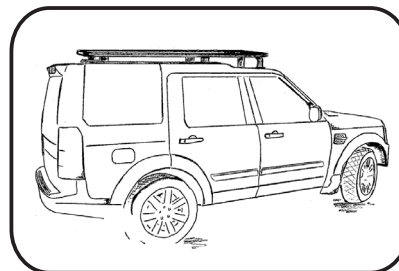

JOB WELL DONE!

Mounting K9 rails onto a VW Amarok

GETTING STARTED:
 Measuring tape
 Small tube of silicone
 4mm allen key
 Flat screwdriver

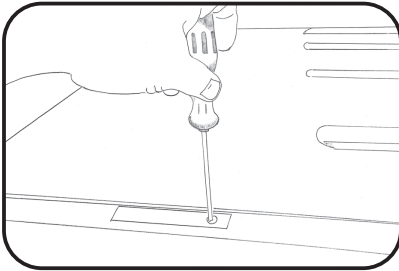

Turn lock in plastic cover plate on roof with flat screwdriver.

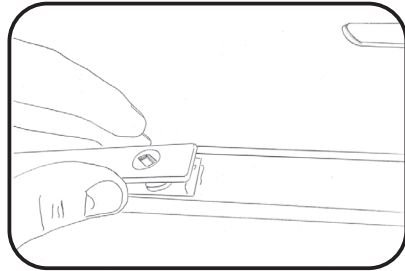

Lift plastic cover plate out to remove.

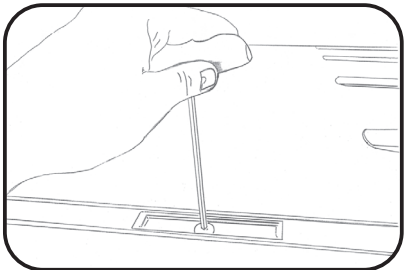

Remove bolts provided with allen key.

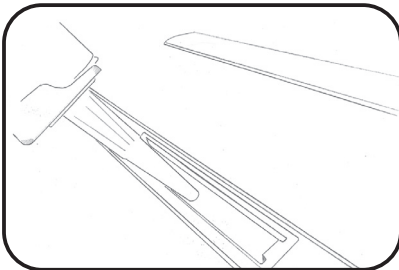

Insert a small amount of silicone into hole.

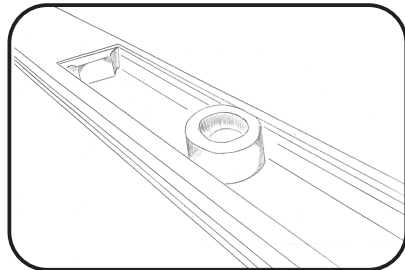

Place aluminium spacer provided into slot.

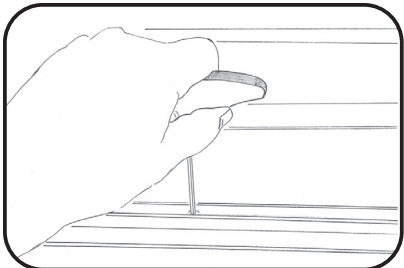

Fasten K9 rail down with bolts provided at the back first.

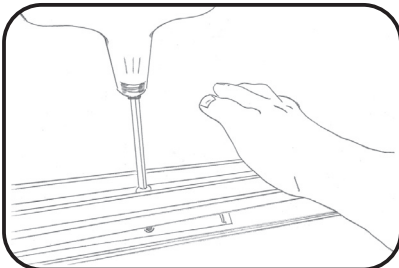

Fasten the K9 rail down with bolts provided at the front by pushing down on K9 rail.

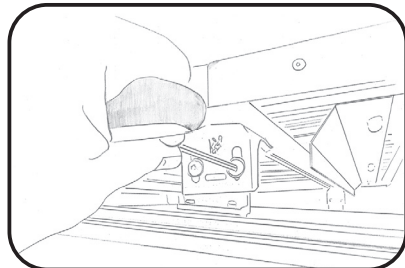

Fit roofrack to rails as per Section 2.

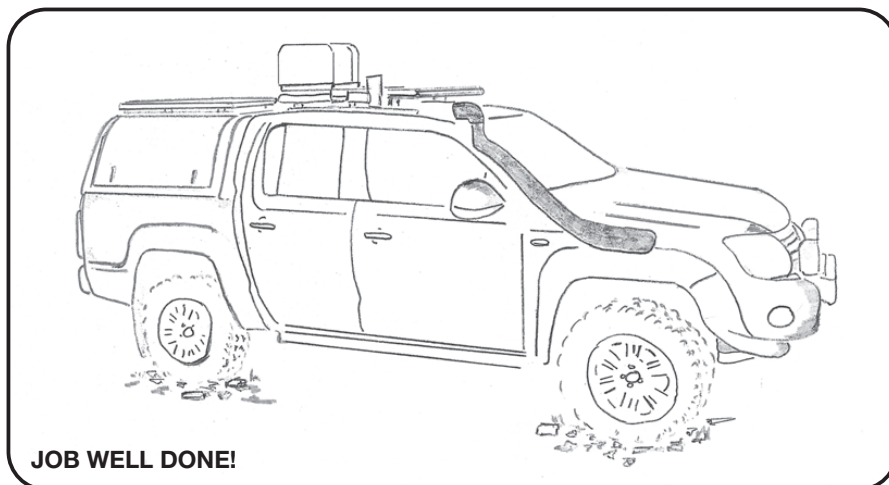



Mounting K9 rails onto double cabs and vehicles without OEM hole insert provided.

GETTING STARTED:

- Socket set
- Flat screwdriver
- Star screwdriver
- 6.5mm drill bit
- Small tube of silicone
- Measuring tape
- 4mm allen key
- Marking pen

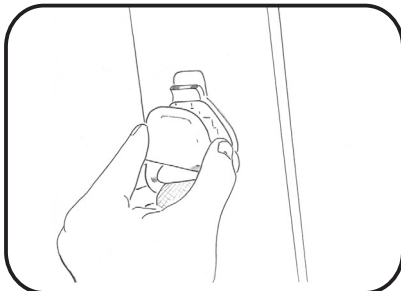

Unclip plastic cover on seatbelt slide.

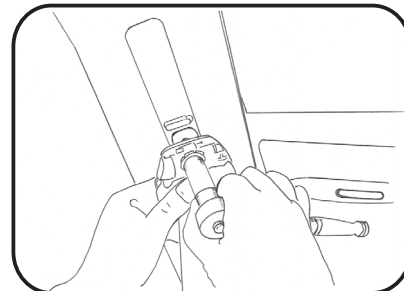

Remove with socket set.

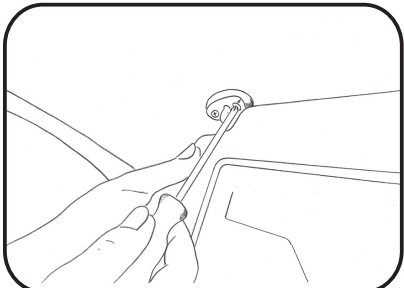

Undo sunvisors with star screwdriver.

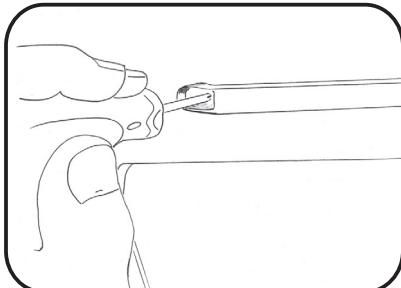

Undo side handles.

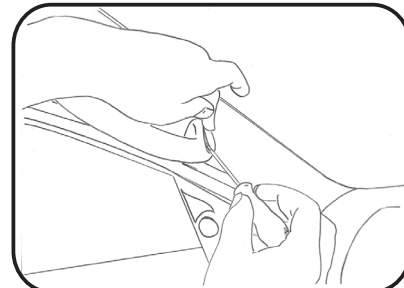

After all handles have been removed unclip plastic cover strips in order to drop hood lining.

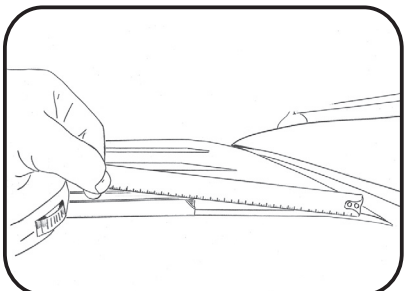

Place K9 rails on roof and use a measuring tape to make sure that they are equal on both sides.

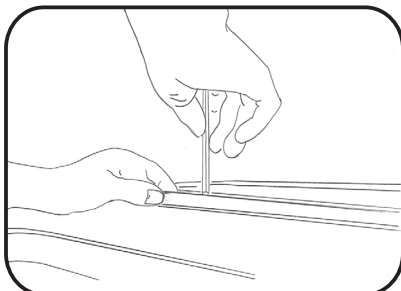

Mark holes with marking pen.

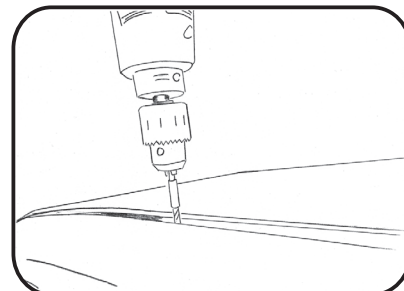

Place tape around drill bit in order to stop drill bit going too deep. Make sure when drilling that you do not drill into airbag actuator.

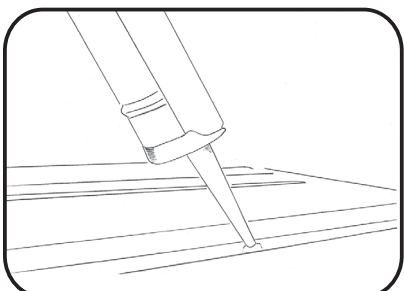

Vacuum holes and silicone.

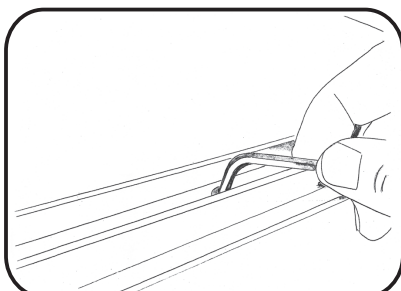

Systematically tighten bolts with 4mm allen key.

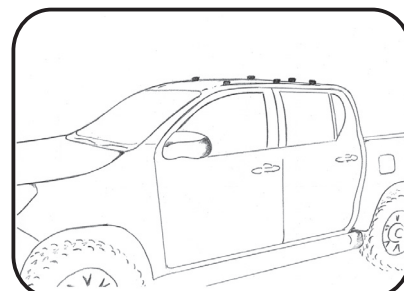

JOB WELL DONE! With regards to mounting the rack, refer to section 2.



EEZI-AWN manufactures specific rails for the 2013 on Ranger and the 2016 Hilux Revo if mounting to these vehicles we suggest you do so with the relevant kits for ease of fitting.

GETTING STARTED:

- Marking pen
- Hacksaw
- 5mm drill bit
- Poprivet gun
- Vacuum cleaner
- Small tube silicone
- 13mm spanner wrench

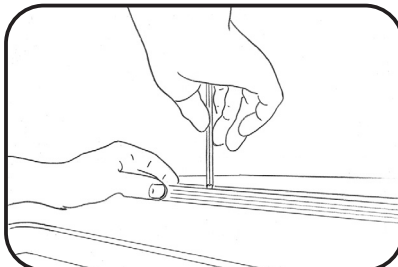

Place rail on roof and mark.

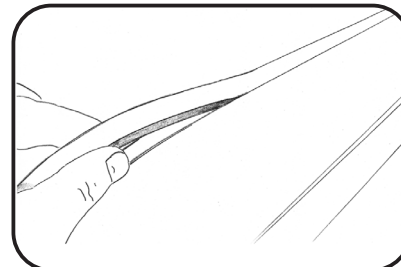

Remove rubber strip by pulling upwards.

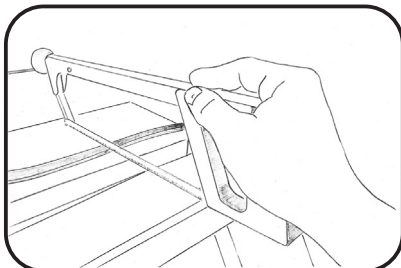

Cut rubber strip with hacksaw using a polystyrene block or similar to protect vehicle roof when cutting.

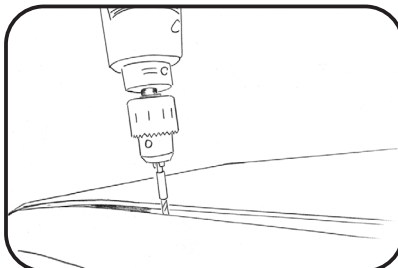

Put rail in roof groove in order to locate holes. Place tape around drill bit in order to stop drill going in too deep.



Lift out rail and vacuum out all loose particles.

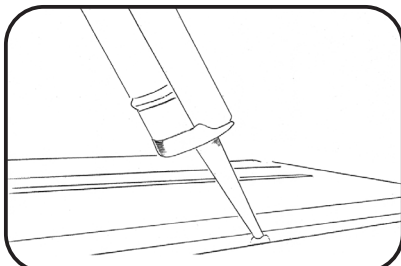

Silicone seal holes.

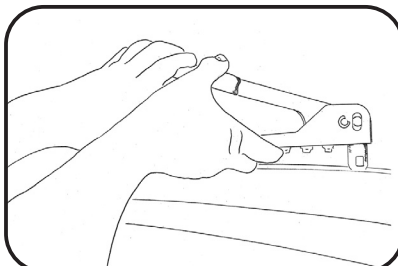

Poprivet rail into place with poprivet gun.

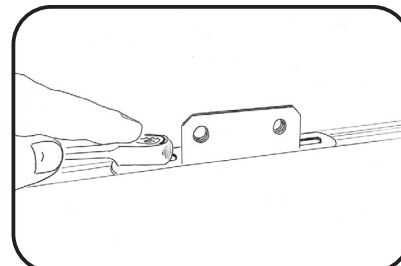

Bolt K9 rail feet in place with 13mm spanner / wrench. Refer to section 2 in order to mount rack.

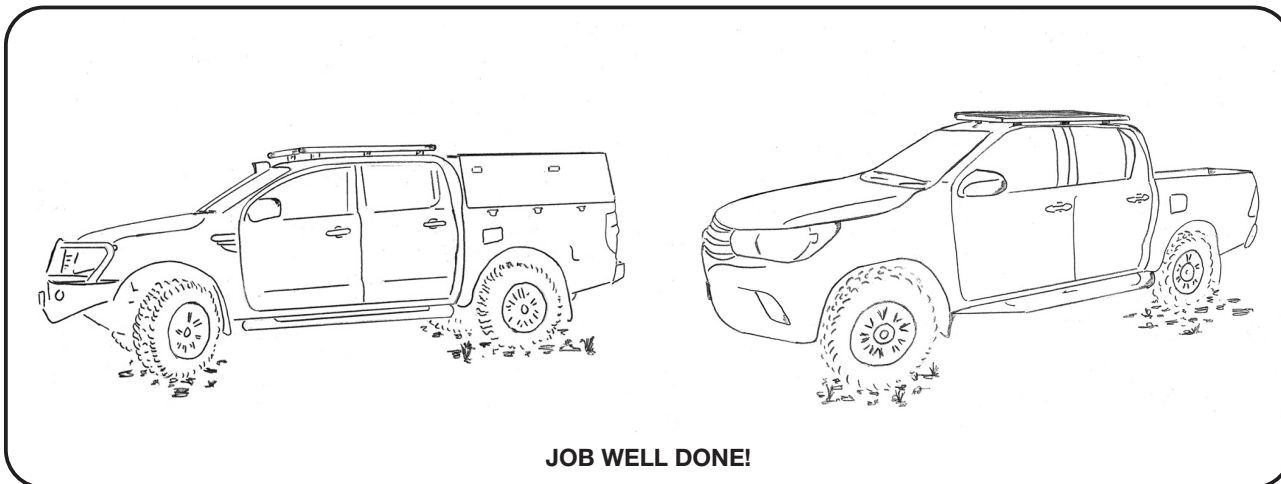

JOB WELL DONE!



K9 ACCESSORIES

All of these accessories mount to the K9 Rack system in minutes. There is no drilling required.

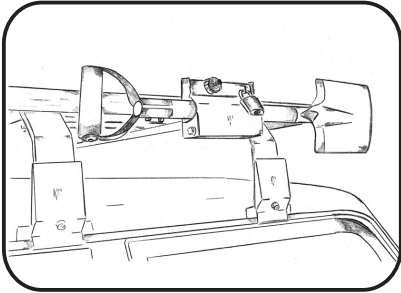

SPADE / SHOVEL AXE KITS.

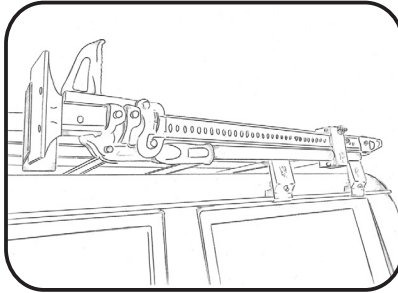

JACK KITS.

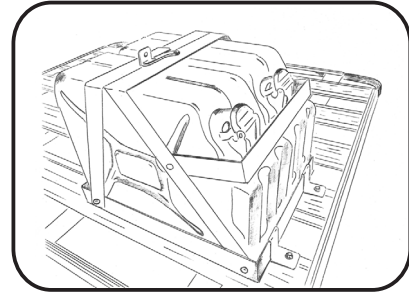

SINGLE, DOUBLE JERRY CAN HOLDER.

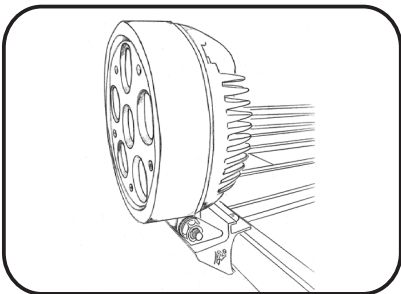

SPOTLIGHT AND LIGHTBAR KIT.

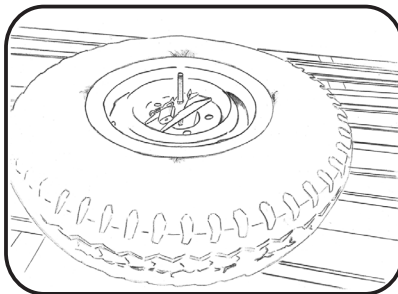

SPARE WHEEL KIT.

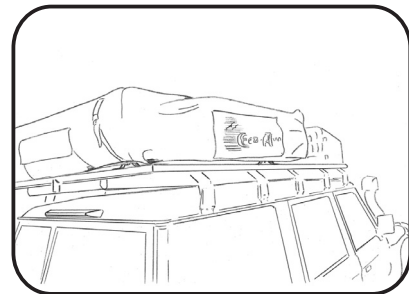

ROOFTENT FITTING KITS.

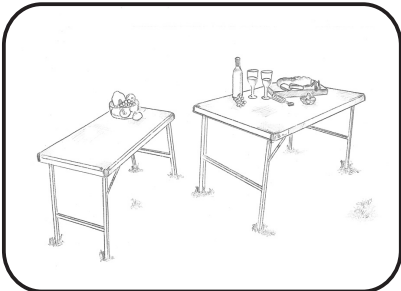

SMALL, MEDIUM, LARGE AND XL TABLES AND UNDER RACK SLIDES.

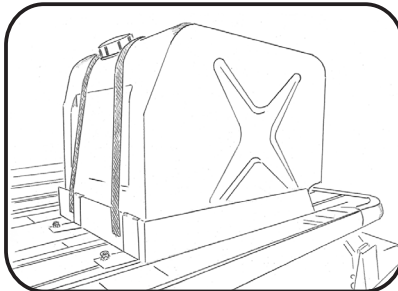

WATER CAN HOLDER.

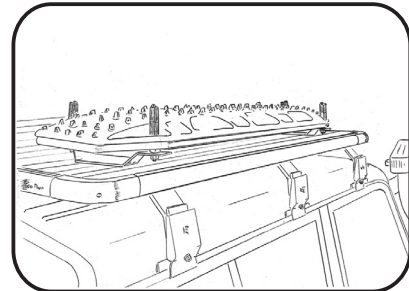

MAX TRAX BRACKET.

K9 LADDERS

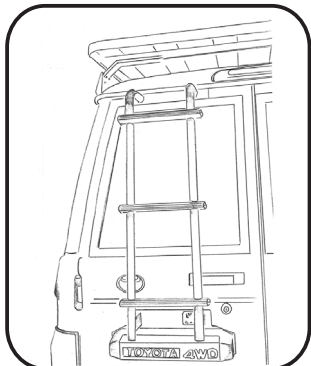

76/78 CRUISER LADDERS

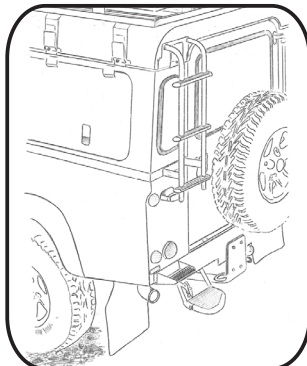

DEFENDER LADDER AND STEP

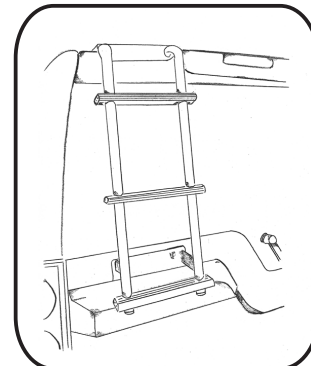

DISO 3/4 LADDER

Should there be an accessory that is not listed above that you would like, please contact your nearest K9 distributor, as chances are we do manufacture it.

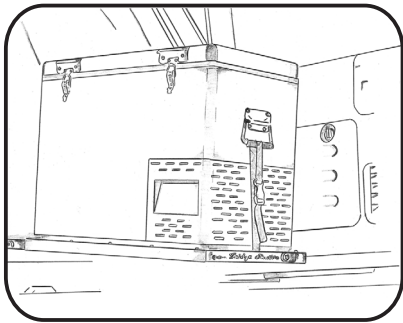

FRIDGE SLIDES



Manufactures a large range of Rec Vee equipment. For more information please contact your nearest distributor or go to www.eeziawn.com

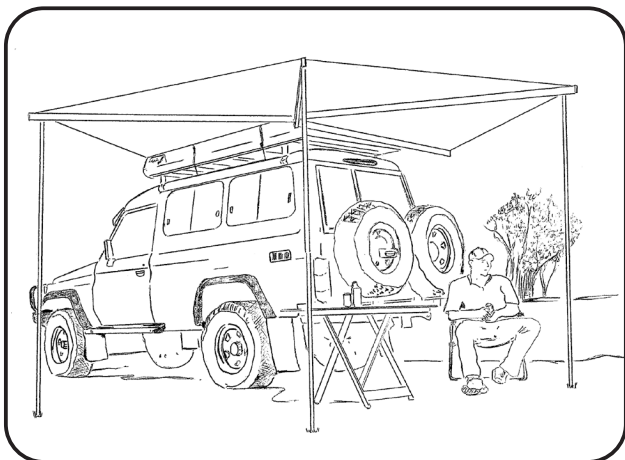

BAT270 AND MANTA 270+

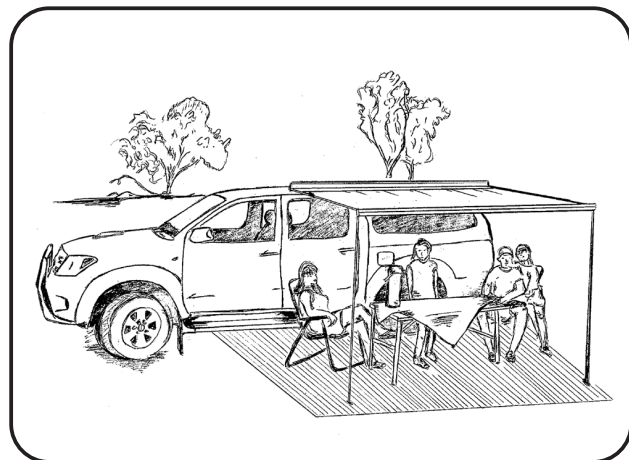

RETRACTABLE AWNINGS

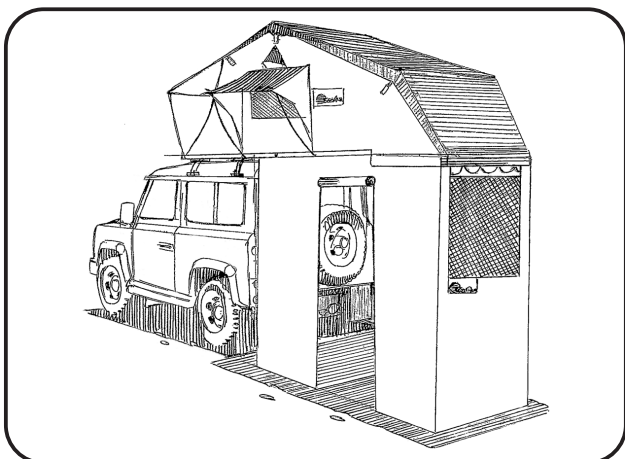

ROOFTENTS

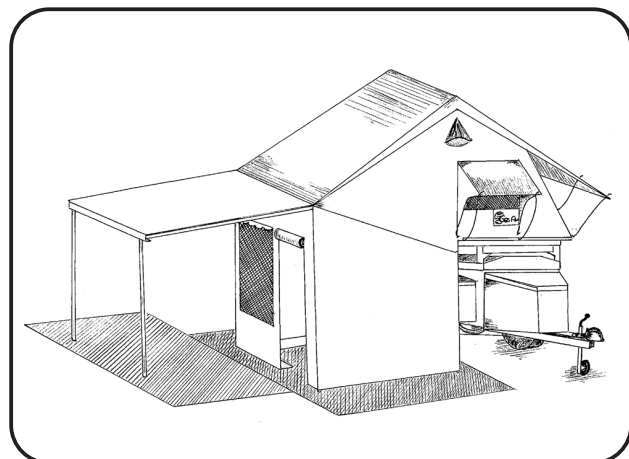

TRAILER TENTS

Eezi-Awn reserves the right to modify their equipment at their own discretion.